

ALPHA iQ

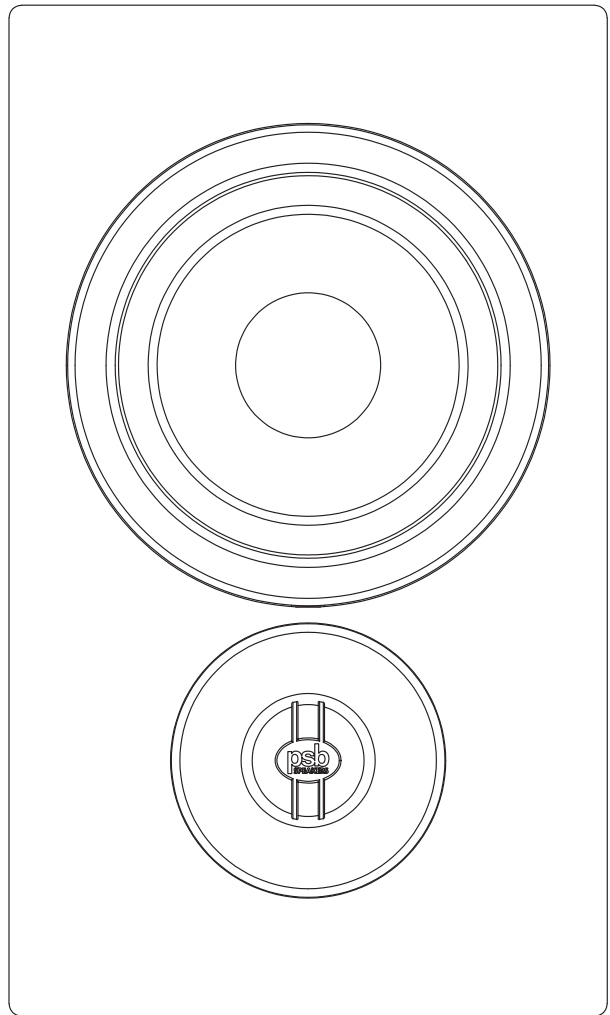
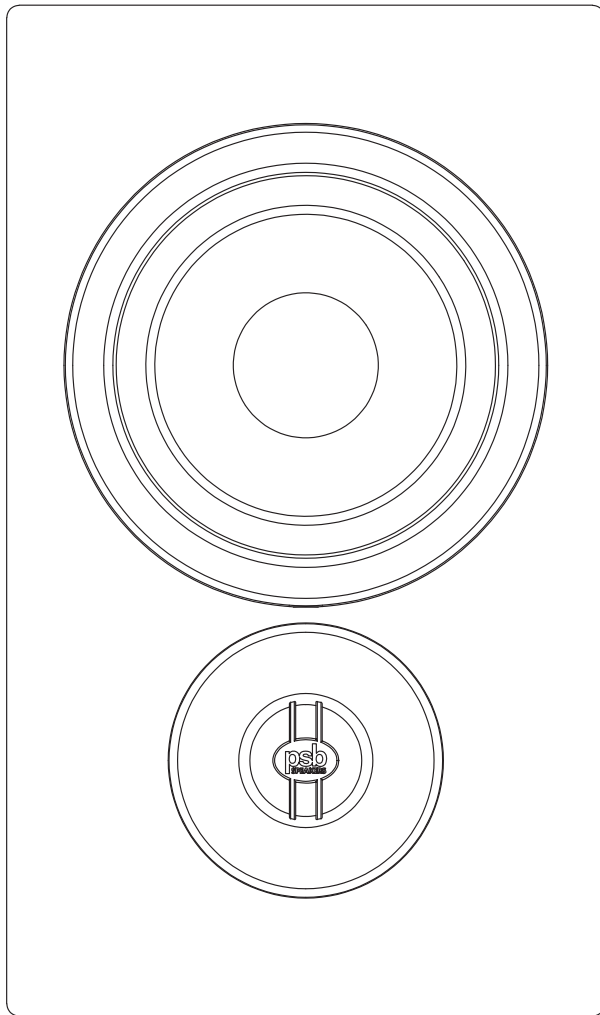

IMPORTANT SAFETY INSTRUCTIONS

1. Read these instructions.
2. Keep these instructions.
3. Heed all warnings.
4. Follow all instructions.
5. Do not use this apparatus near water.
6. Clean only with a dry cloth.
7. Do not block any of the ventilation openings. Install in accordance with the manufacturer's instructions.
8. Do not install near any heat sources such as radiators, heat registers, stoves, or other apparatus (including amplifiers) that produce heat.
9. Do not defeat the safety purpose of the polarized or grounding type plug. A polarized plug has two blades with one wider than the other. A grounding type plug has two blades and a third grounding prong. The wide blade or the third prong is provided for your safety. When the provided plug does not fit into your outlet, consult an electrician for replacement of the obsolete outlet.
10. Protect the power cord from being walked on or pinched particularly at plugs, convenience receptacles, and the point where they exit from the apparatus.
11. Only use the attachments/accessories specified by the manufacturer.
12. Use only with a cart, stand, tripod, bracket, or table specified by the manufacturer, or sold with the apparatus. When a cart is used, use caution when moving the cart/apparatus combination to avoid injury from tip-over.
13. Unplug this apparatus during lightning storms or when unused for long periods of time.
14. Refer all servicing to qualified service personnel. Servicing is required when the apparatus has been damaged in any way, such as power supply cord or plug is damaged, liquid has been spilled or objects have fallen into the apparatus, the apparatus has been exposed to rain or moisture, does not operate normally, or has been dropped.
15. The apparatus shall not be exposed to dripping or splashing and that no objects filled with liquids, such as vases, shall be placed on the apparatus.
16. To reduce the risk of fire or electric shock, this apparatus should not be exposed to rain or moisture.
17. The mains plug or an appliance coupler is used as the disconnect device, the disconnect device shall remain readily operable.

WARNING



The lightning flash with arrowhead symbol, within an equilateral triangle, is intended to alert the user to the presence of uninsulated "dangerous voltage" within the product's enclosure that may be of sufficient magnitude to constitute a risk of electric shock to persons.



The exclamation point within an equilateral triangle is intended to alert the user to the presence of important operating and maintenance (servicing) instructions in the literature accompanying the product.

FCC WARNING

This device complies with part 15 of the FCC Rules. Operation is subject to the following two conditions:

1. This device may not cause harmful interference, and
2. This device must accept any interference received, including interference that may cause undesired operation.

Any changes or modifications not expressly approved by the party responsible for compliance could void the user's authority to operate the equipment.

FCC STATEMENT

This equipment has been tested and found to comply with the limits for a Class B digital device, pursuant to part 15 of the FCC Rules. These limits are designed to provide reasonable protection against harmful interference in a residential installation. This equipment generates uses and can radiate radio frequency energy and, if not installed and used in accordance with the instructions, may cause harmful interference to radio communications. However, there is no guarantee that interference will not occur in a particular installation. If this equipment does cause harmful interference to radio or television reception, which can be determined by turning the equipment off and on, the user is encouraged to try to correct the interference by one or more of the following measures:

- Reorient or relocate the receiving antenna.
- Increase the separation between the equipment and receiver.
- Connect the equipment into an outlet on a circuit different from that to which the receiver is connected.
- Consult the dealer or an experienced radio/TV technician for help. This equipment complies with FCC radiation exposure limits set forth for an uncontrolled environment. This equipment should be installed and operated with a minimum distance of 20 cm between the radiator and your body.

IC WARNING

This radio transmitter has been approved by Industry Canada. This Class B digital apparatus complies with Canadian standard ICES-003. This device complies with Industry Canada License exempt RSS standard(s). Operation is subject to the following two conditions.

1. This device may not cause interference and
2. This device must accept any interference, including interference that may cause undesired operation of the device.

This equipment complies with ISED radiation exposure limits set forth for an uncontrolled environment. This equipment should be installed and operated with a minimum distance of 20 cm between the radiator and your body.

INTRODUCTION

Thank you for your PSB Speakers purchase. Our wide collection of high-performance loudspeakers, headphones, and home audio products bring music and video collections to life. Producing natural musical dynamics and precise imaged sound, PSB Speakers will simply bring you closer to the music you love.

Alpha stands for the best value in high performance loudspeakers. The Alpha iQ Streaming Powered Speakers with BluOS make it easy to enjoy PSB's signature "True to Nature" sound from your favorite streaming services and legacy sources—without cable clutter! Comprising two wireless bookshelf speakers with built-in amplifiers, PSB's Alpha iQ is an all-in-one audio system for the streaming age. The Primary and Secondary Speakers communicate via a wireless link that can cover most rooms in an average-size home without delays or latency, so music stays sync and clear regardless of speaker placement.

By supplying this owner's guide, we hope you will read through this information to assure you that you are getting the most out of your PSB product.

Unpacking

The packing materials are designed to protect the speakers from damage during transport. However, if visible or concealed damage is to occur in handling, it should be reported at once to your authorized PSB dealer, or to the shipping company that delivered your loudspeakers. We highly recommend retaining all packaging, as it may be needed to transport the speakers in the future.

What's in the Box

Packed with your Alpha iQ you will find:

- Two pairs of power cord for North America
- Two pairs of power cord for Europe
- Ethernet cord
- 3.5 mm analog cable

IDENTIFICATION OF CONTROLS

Front - Primary and Secondary Speaker

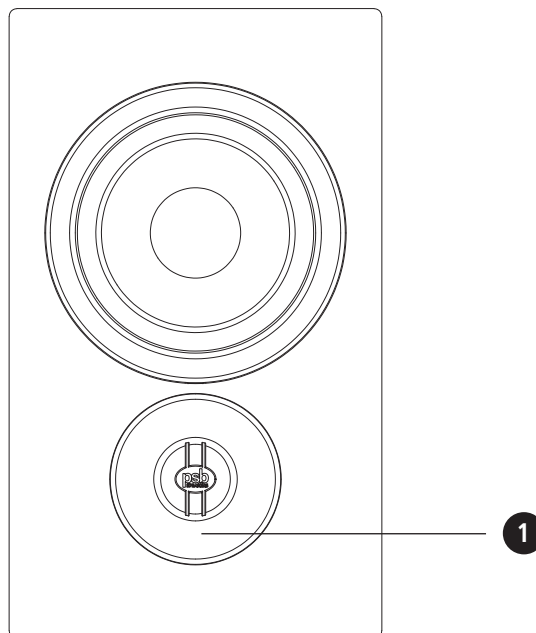

1. Status Indicator

Below is a table of the LED blink codes and their corresponding descriptions.

LED BLINK CODE	DESCRIPTION
Blinking green	Trying to connect to Wi-Fi Network
Solid green	Hotspot mode (Ready for Setup)
Alternately blinking red and green	Installing upgrade
Solid purple	Hotspot mode timeout • Press and Hold Play/Pause for 5 seconds to resume hotspot mode
Solid red	Initialization and upgrade mode
Alternately blinking blue and purple	Not paired
Solid blue	Connected to network and Ready to use with BluOS App

Top Panel - Primary Speaker

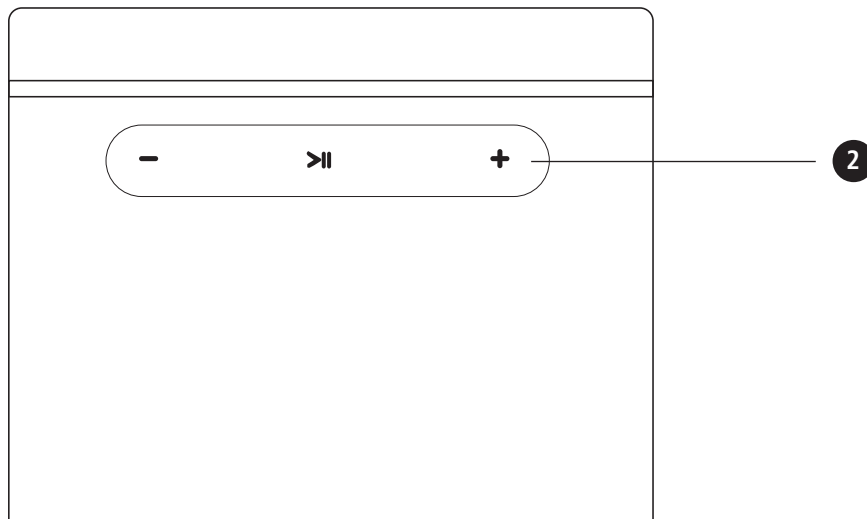

2. >||,+, -

>||

- Press to play, pause or resume playback of current song.
- Use also for restoring Primary Speaker to factory default settings. Refer to section about FACTORY RESET.

+, -

- Use to vary volume level. Tap + to increase the volume level or - to decrease the volume level in 1 dB intervals. This volume tap method allows you to fine-tune your volume setting.

Back Panel - Primary Speaker

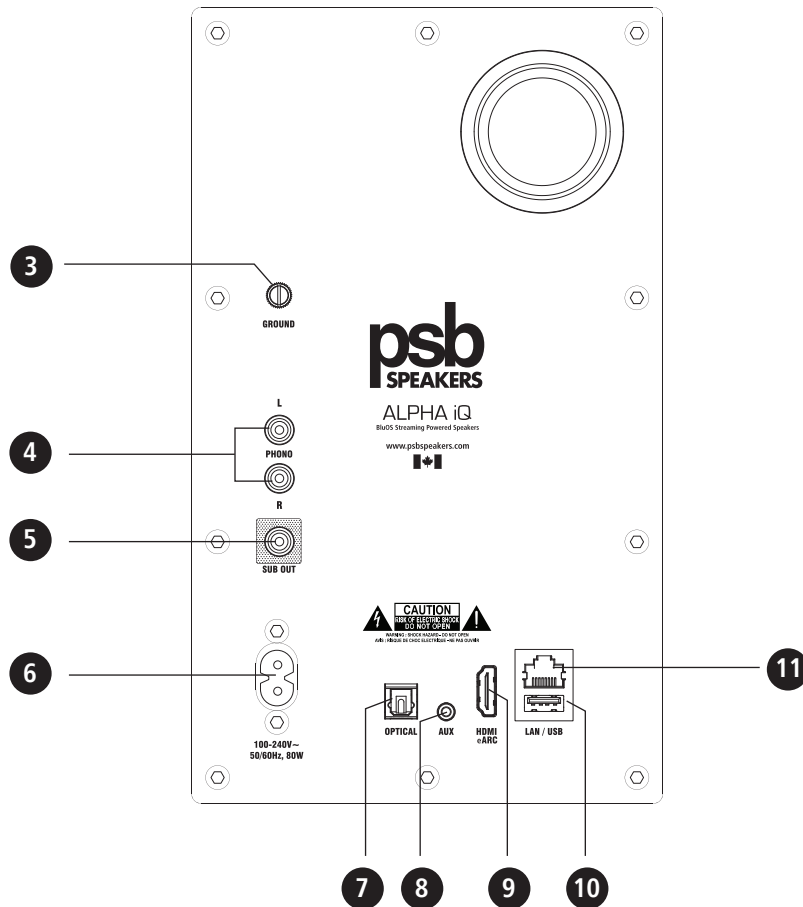

3. Ground

- Connect to this Ground terminal if your turntable includes a ground/earth lead.
- If necessary, use this Ground terminal to connect to ground a phono or turntable source for PHONO input.
- If a separate earth ground is necessary, use this terminal to ground your Alpha iQ.
- The Alpha iQ can be connected to Ground by connecting a ground lead wire or similar to this terminal. After insertion, tighten the terminal to secure the lead.

4. Phono

- Input for a Moving Magnet (MM) phono cartridge only.

5. Sub Out

- Connect to low-level input of an external active subwoofer using a subwoofer interconnect cable.
- With your Subwoofer connected, go to **Audio** in the **Settings** menu of the BluOS App. Enable your Subwoofer under **Subwoofer** option and set preferred crossover settings under **Crossover** option.

6. Power Inlet (Primary)

- The ALPHA iQ comes supplied with two pairs of power cords. Select the power cord appropriate for your region.
- Before connecting the power cord's plug to the mains power outlet, ensure that the other end of the power cord is firmly connected to ALPHA iQ's Power Inlet.
- Always disconnect the power cord's plug from the mains power outlet before disconnecting the other end of the power cord from the ALPHA iQ's Power Inlet.

7. Optical

- Using a TOSLINK optical cable (not supplied), connect to corresponding optical digital output of sources such as CD or BD/DVD players, digital cable box, digital tuners and other applicable components.

8. Aux

- Using the supplied 3.5mm analog cable to connect one end to AUX input and the opposite end to the selected analog audio source.

9. HDMI

- Use HDMI cable (not supplied) to connect this HDMI port to corresponding HDMI port of TV. Use HDMI cable that has Ultra-High-Speed HDMI Certification Label to enjoy support for larger bandwidth and high bitrate format.
- Ensure that the audio setting/format of the connected device to ALPHA iQ is set to PCM only.
- Only audio output signal from TV is supported by the Alpha iQ via the HDMI port.

10. LAN

- LAN connection must be set up for wired connection to be established. Set up a Wired Ethernet broadband router with broadband internet connection. Your router or home network should have a built-in DHCP server to consummate the connection.
- Using the supplied Ethernet cable, connect one end of the Ethernet cable to the LAN port of your wired Ethernet broadband router and the other end to ALPHA iQ's LAN port.

Notes PSB is not responsible for any malfunction of the ALPHA iQ and/or the internet connection due to communication errors or malfunctions associated with your broadband internet connection or other connected equipment. Contact your Internet Service Provider (ISP) for assistance or the service bureau of your other equipment.

Contact your ISP for policies, charges, content restrictions, service limitations, bandwidth, repair and other related issues pertinent to internet connectivity.

11. USB

- Connect to this USB port a USB mass storage device formatted as FAT32, NTFS or Linux ext4. The connected USB device appears as a Local Source (USB) in the BluOS App.
- Access and playback music stored in the connected USB device by selecting "USB" from the BluOS App.

Back Panel - Secondary Speaker

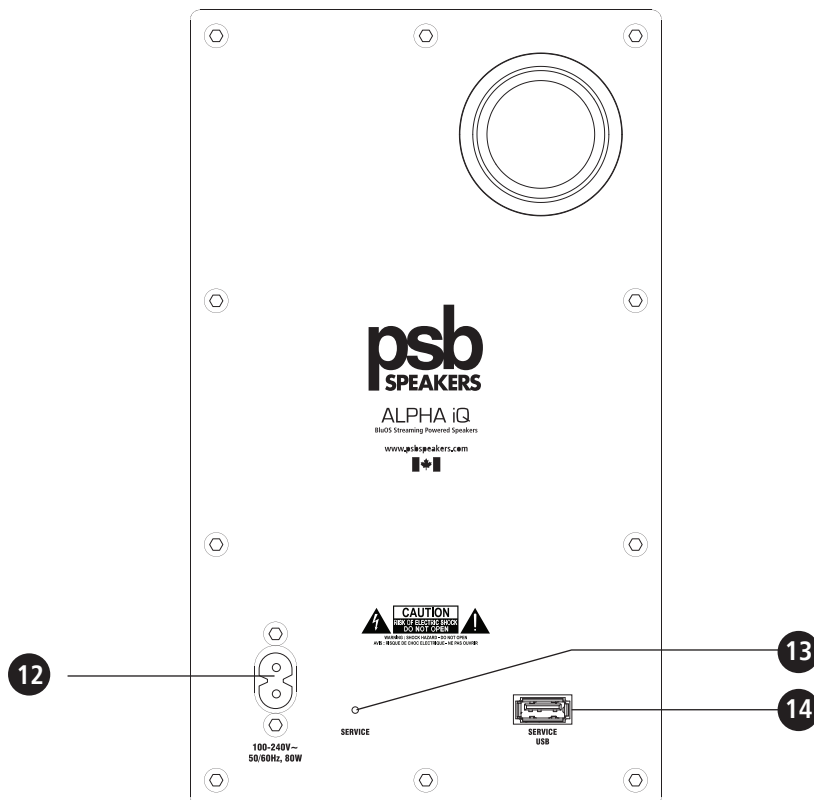

12. Power Inlet (Secondary)

- The ALPHA iQ comes supplied with two pairs of power cords. Select the power cord appropriate for your region.
- Before connecting the power cord's plug to the mains power outlet, ensure that the other end of the power cord is firmly connected to ALPHA iQ's Power Inlet.
- Always disconnect the power cord's plug from the mains power outlet before disconnecting the other end of the power cord from the ALPHA iQ's Power Inlet.

13. Service

- Use for restoring Secondary Speaker to factory default settings. Refer also to section about FACTORY RESET.

14. Service/USB

- SERVICE/USB port is for internal use only and not for customer use.

ALPHA iQ BEST PRACTICES

Network Considerations

Streaming music content from the internet is dependent upon the internet download speed as well as your home network itself. The strength and coverage of your Wi-Fi network is the most important factor in determining how well a streaming service can deliver content throughout your home.

Here is a list of ways to improve the performance of your Alpha iQ.

1. Wired is always better than wireless. Although the Alpha iQ is equipped to carry out all functions wirelessly, normal networking principals apply. In general, Wired ethernet connection has faster and more consistent download speed than Wireless connection. Wi-Fi transmission can be affected by other wireless signals wherein there may be interference in the communication between the network and receiver. Wherever possible, connect your Alpha iQ via Wired network connection.
2. Check Wireless Signal Strength. If you choose to use the Alpha iQ wirelessly, it is recommended that you check the signal strength between the Alpha iQ and your home network. This can be done within the BluOS App. Go to the Help section found at the bottom of the list of sources. From the help menu, choose Diagnostics. The antenna symbol shows the signal strength. If the signal rating is Poor or alternates between Fair and Poor, an adjustment may be necessary. Several options can improve signal strength.

Visit <https://support.bluos.net/hc/en-us/sections/360000042348> for some Networking tips.

Set Up One System at a Time

Alpha iQ is designed to establish a unique link between the Primary Speaker and Secondary Speaker. Once wireless bond is established between the speakers, they will remain connected regardless of any additional active Alpha iQ systems throughout the home. This bond will remain even after a power outage. It is crucial to conduct the setup process one pair at a time to ensure the bond between the correct speakers is properly established.

SETUP GUIDE

Your Alpha iQ can be connected to your home network via Wired or Wireless connection. Setting up your Alpha iQ can be undertaken using either Android or iOS BluOS App only.

Important Setup Conditions

Before going through the Setup process of your Alpha iQ, ensure the following are undertaken.

- Connect both Alpha iQ Primary and Secondary Speaker to mains power. Connect the power cord's plug to the mains power outlet ensuring that the other end of the AC power cord is firmly connected to ALPHA iQ's Power Inlet.
- For wired and wireless connection to be established, ensure that a broadband router that supports Ethernet and/or Wi-Fi standards is set up and available.
- Tablets, smartphones and other applicable devices that support iOS or Android operating system can be used as mobile device controllers. These devices are not supplied with your Alpha iQ.

- Download and install the corresponding “BluOS Controller” App for your device.
- The BluOS App is available as a Mobile App for Android, iOS, Kindle and Desktop App for Windows and macOS computers.
- Mobile Apps are handled by the respective Application Store of the Mobile devices.
- Desktop Apps are available to download directly from the Bluesound homepage - <https://bluos.net/downloads>
- Always update the BluOS App version in your device to the latest version.

Important! The foregoing sequence of events or indicators may vary or subject to change without notice.

Wired Connection

1. With both Primary and Secondary Speakers powered up, ensure that both speakers’ Status Indicator LEDs are solid Green in color.

Note If the Status Indicator LED of Primary or Secondary Speaker is not solid green, perform Factory Reset of that specific Speaker.

2. Connect one end of the supplied Ethernet cable to the Primary Speaker’s LAN port and the other end directly to your Wired network or router.
3. Launch iOS or Android BluOS App connected to the same network or router as the Primary Speaker. Android BluOS App used in this example.
4. The App may immediately prompt **Needs Setup** and show the unique network ID of your Alpha iQ (listed as the product name followed by four digits like “Alpha iQ-0004” for example).
 - a. If you are not prompted, open the Player Drawer by pressing the Home icon in the top right corner of the App.
 - b. Scroll to the bottom and select **ADD A PLAYER** to launch the Easy Setup Wizard.

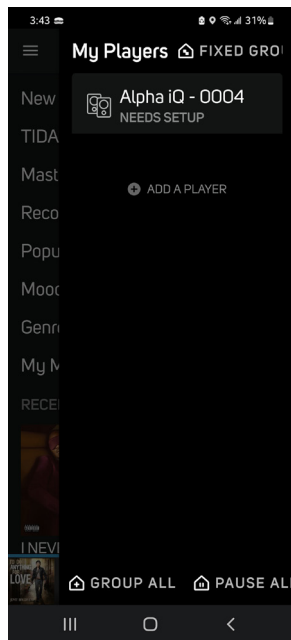

5. Select the Primary Speaker's unique network ID ("Alpha iQ-0004" in this example) from the **Needs Setup** or **My Players** App screen.

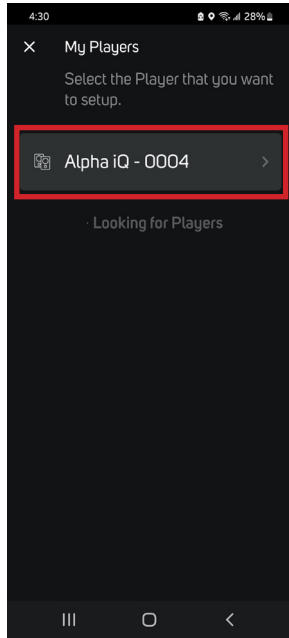

6. Enter the **Name** you prefer your Alpha iQ-0004 to be customized for easier identification in the Player Drawer. You can retain Alpha iQ-0004 or select from the **Name Suggestions** provided. After finalizing your choice of designated name for your Alpha iQ, select **Continue**.

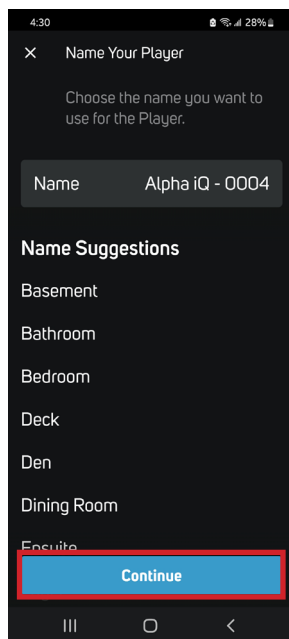

7. The Secondary Speaker is now ready for pairing. Select **Start Pairing**.

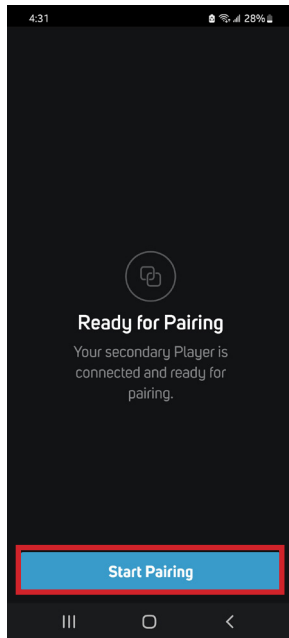

8. The Primary Speaker starts making a sound. Select the Primary Speaker's position in your setup (Left or Right side) and select **Continue**.

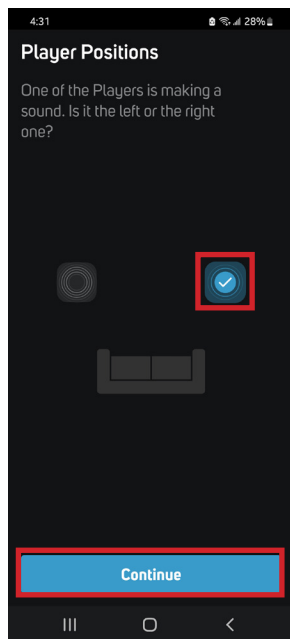

The setup process will continue automatically. It will pass through **Linking to Secondary**, checking for upgrades to your Speakers (**Looking for Upgrade**) and automatically updates the current Speaker if an upgrade is available. **Do not interrupt or power down your Alpha iQ during this stage of the setup process.**

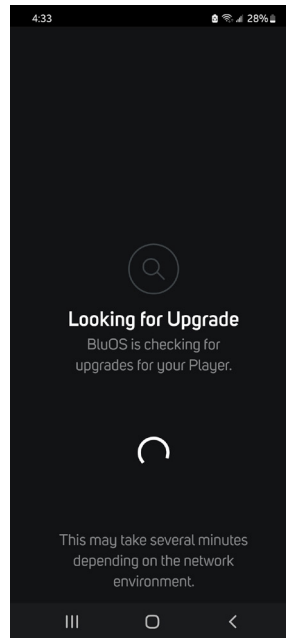
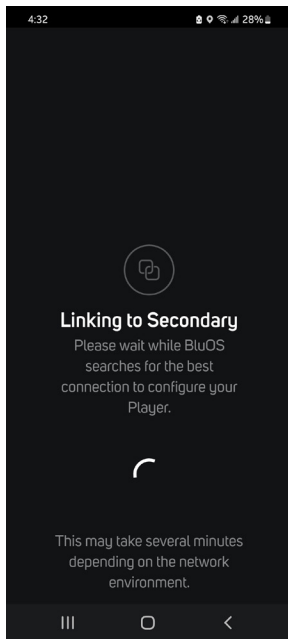

Important During this stage of the setup process, **Linking to Secondary** and **Looking for Upgrade** may take up to 15 minutes to complete. This is normal. Do not interrupt or power down your Alpha iQ during this stage of the setup process.

9. When **Setup Complete** is shown in the App, this indicates that your Alpha iQ is ready for use. Select **Finish** to complete and exit the setup process.

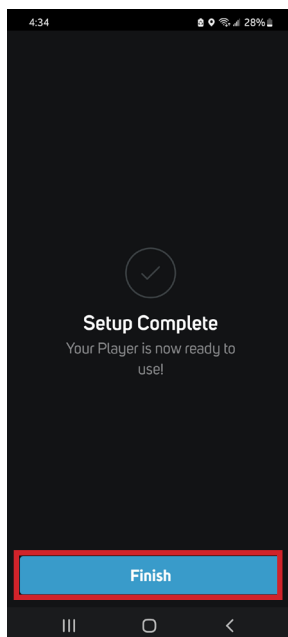

Wireless Connection

The process slightly differs between iOS (Apple) and Android devices. Follow below instructions for the smartphone or tablet that applies to you.

Android

1. With both Primary and Secondary Speakers powered up, ensure that both speakers' Status Indicator LEDs are solid Green in color.

Note If the Status Indicator LED of Primary or Secondary Speaker is not solid green, perform Factory Reset of that specific Speaker.

2. Launch Android BluOS App connected to the same network or router as the Primary Speaker.
3. The App may immediately prompt **Needs Setup** and show the unique network ID of your Alpha iQ (listed as the product name followed by four digits like "Alpha iQ-0004" for example).
 - a. If you are not prompted, open the Player Drawer by pressing the Home icon in the top right corner of the App.
 - b. Scroll to the bottom and select **Add a Player** to launch the Easy Setup Wizard.

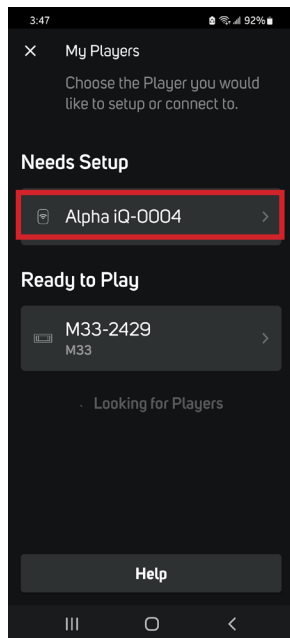

4. Select the Primary Speaker's unique network ID ("Alpha iQ-0004" in this example) from the **Needs Setup** or **My Players** App screen.

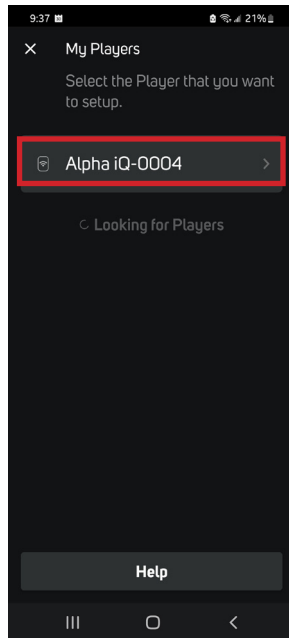

5. An on-screen prompt like below will appear. Select **Continue**.

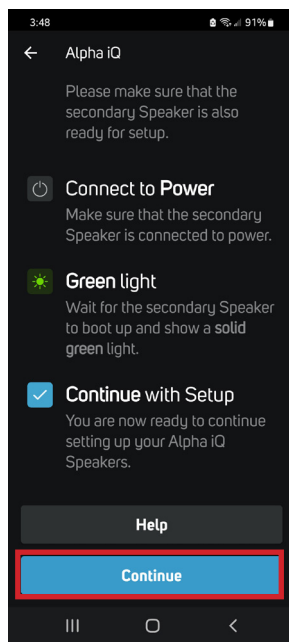

6. Select your Home Wi-Fi Network from the **Choose WiFi Network** drop down menu.
- a. If your Home Wi-Fi Network does not appear or is hidden, select **Manual SSID Entry**. Enter network or applicable wireless network name.

b. Select the **Network Security** your network uses.

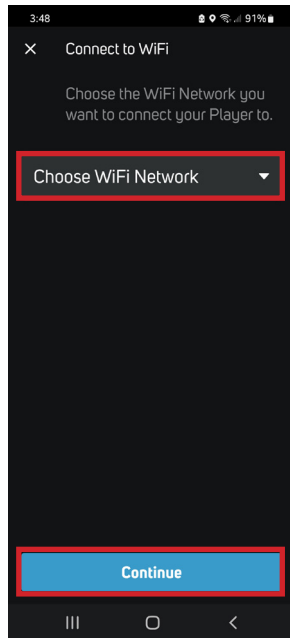

7. Enter your home network's Wi-Fi **Password** in the field provided and select **Continue**.

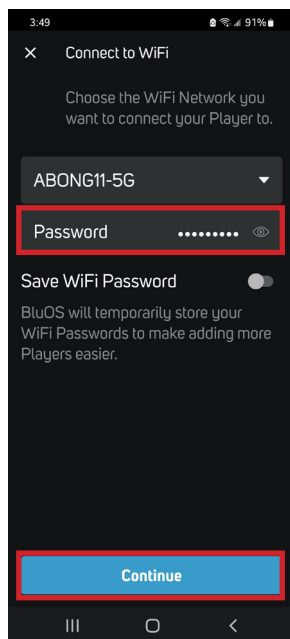

8. Enter the **Name** you prefer your Alpha iQ-0004 to be customized for easier identification in the Player Drawer. You can retain Alpha iQ-0004 or select from the **Name Suggestions** provided. After finalizing your choice of designated name for your Alpha iQ, select **Continue**.

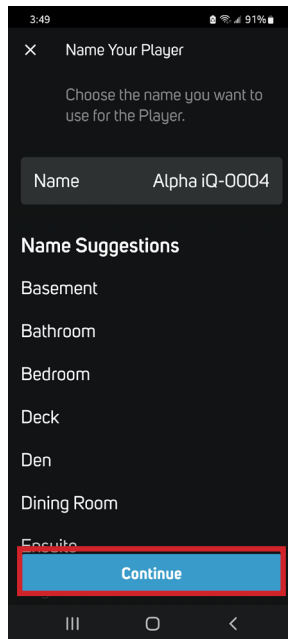

9. Network setup connection proceeds automatically. It will pass through the process of **Connecting to WiFi** and checking for upgrades to your Speakers (**Looking for Upgrade**) and automatically updates the current Speaker if an upgrade is available. **Do not interrupt or power down your Alpha iQ during this stage of the setup process.**

Important If there is an upgrade available for the current Speaker, it will be automatically updated. This may take up to 15 minutes to complete. This is normal. Do not interrupt or power down your Alpha iQ during this stage of the setup process!

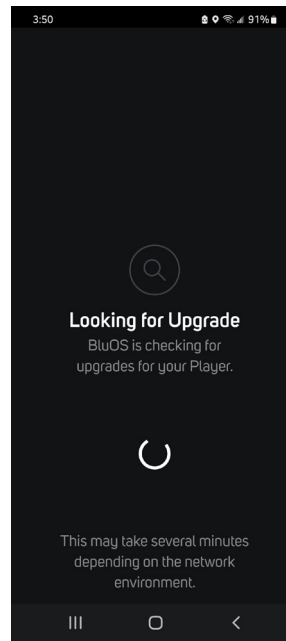
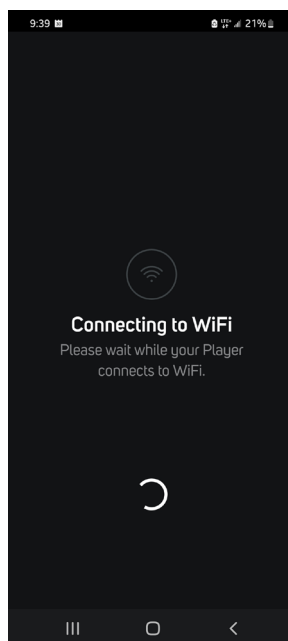

10. The Secondary Speaker is now Ready for Pairing. Select **Start Pairing**.

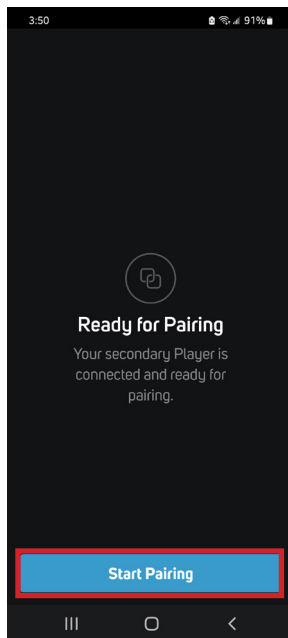

11. The Primary Speaker starts making a sound. Select the Primary Speaker's position in your setup (Left or Right side) and select **Continue**.

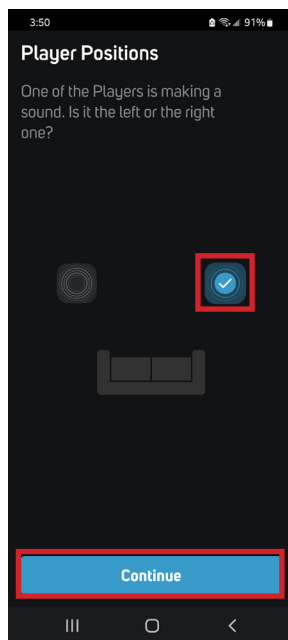

The setup process will continue automatically. It will pass through **Linking to Secondary**, checking for upgrades to your Speakers (**Looking for Upgrade**) and automatically updates the current Speaker if an upgrade is available. **Do not interrupt or power down your Alpha iQ during this stage of the setup process.**

Important During this stage of the setup process, **Linking to Secondary** and **Looking for Upgrade** may take up to 15 minutes to complete. This is normal. Do not interrupt or power down your Alpha iQ during this stage of the setup process.

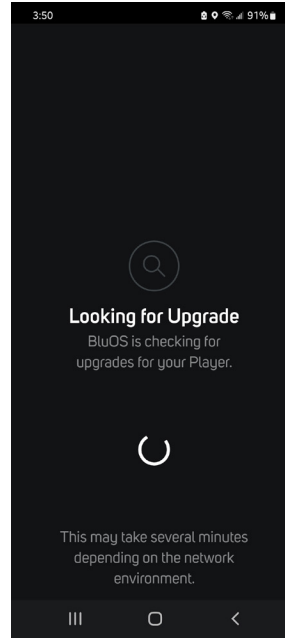
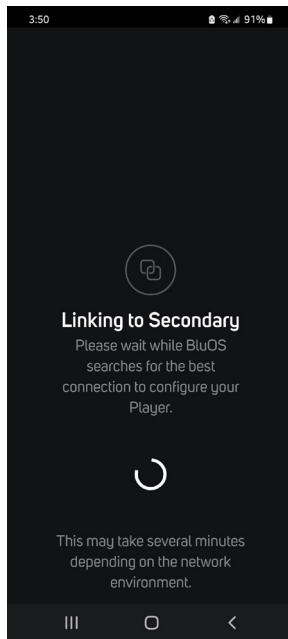

12. When **Setup Complete** is shown in the App, this indicates that your Alpha iQ is ready for use. Select **Finish** to complete and exit the setup process.

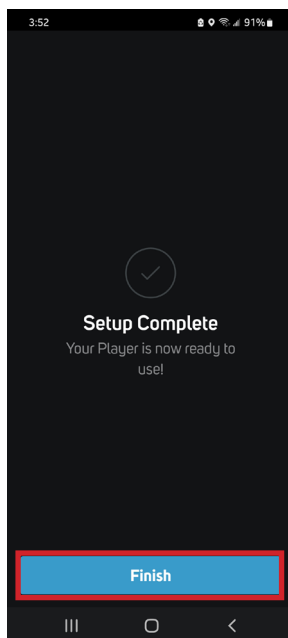

iOS

1. With both Primary and Secondary Speakers powered up, ensure that both speakers' Status Indicator LEDs are solid Green in color.

Note If the Status Indicator LED of Primary or Secondary Speaker is not solid green, perform Factory Reset of that specific Speaker.

2. Launch iOS BluOS App connected to the same network or router as the Primary Speaker.
3. The App may immediately prompt **Needs Setup** and show the unique network ID of your Alpha iQ (listed as the product name followed by four digits like "Alpha iQ-0004" for example).
 - e. If you are not prompted, open the Player Drawer by pressing the Home icon in the top right corner of the App.
 - f. Scroll to the bottom and select **Add a Player** to launch the Easy Setup Wizard.
4. Select the Primary Speaker's unique network ID ("Alpha iQ-0004" in this example) from the **Needs Setup** or **My Players** App screen.

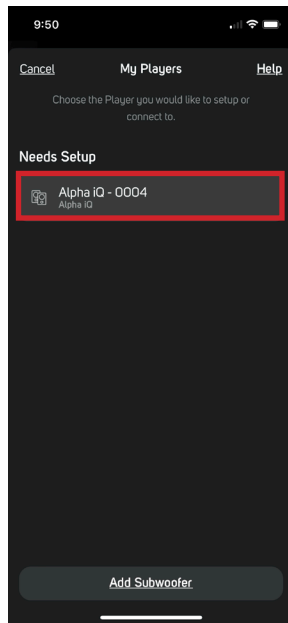

5. An on-screen prompt like below will appear. Select **Continue**.

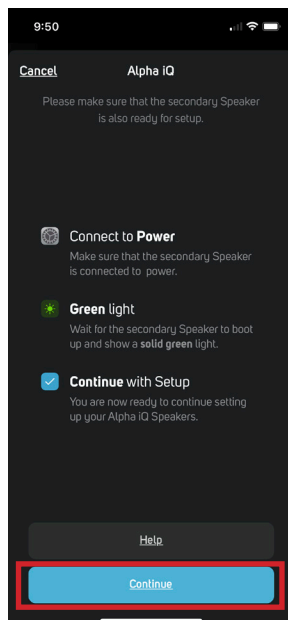

6. Network setup connection proceeds automatically. Follow the on-screen prompt to connect your Speaker to your home network.

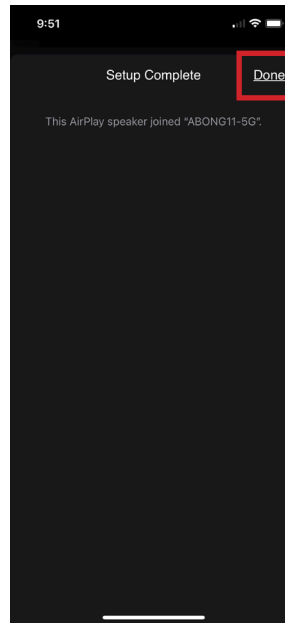
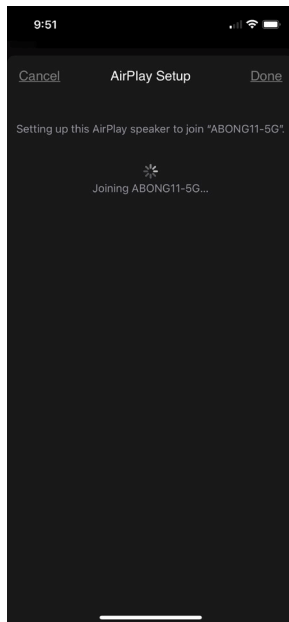
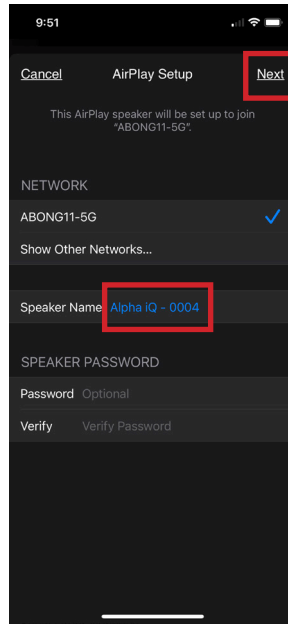
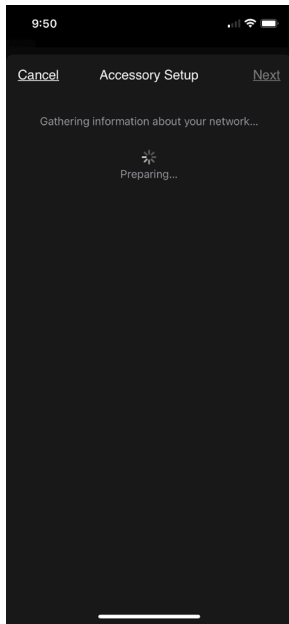

- Once the Speaker is connected to your home network, it will look for upgrades to the Speaker. If an upgrade is available, the current Speaker is automatically updated. **Do not interrupt or power down your Alpha iQ during this stage of the setup process.**

Important If an upgrade is available to the current Speaker, it will be automatically updated. This may take up to 15 minutes to complete. This is normal. Do not interrupt or power down your Alpha iQ during this stage of the setup process!

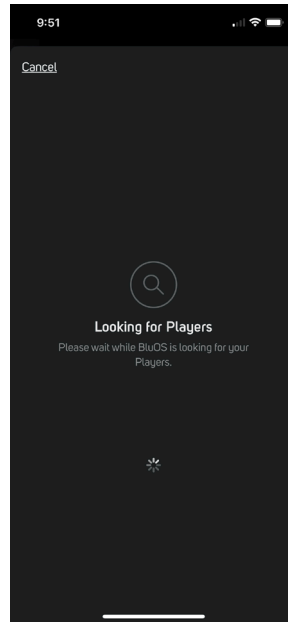
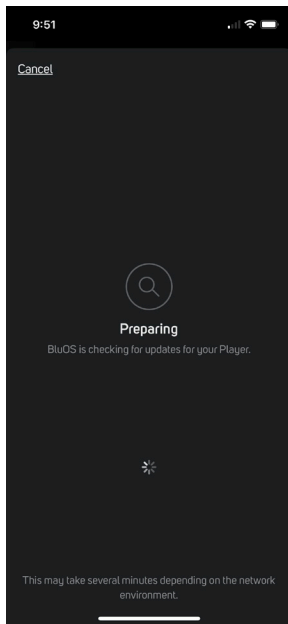

- The Secondary Speaker is now **Ready for Pairing**. Select **Start Pairing**.

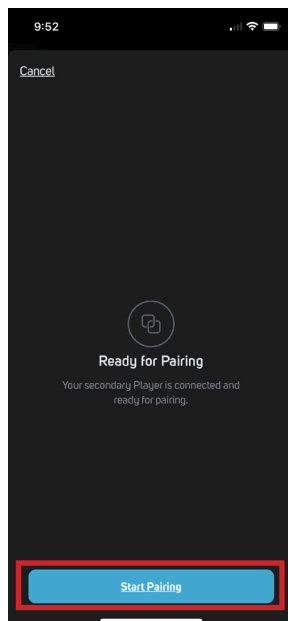

9. The Primary Speaker starts making a sound. Select the Primary Speaker's position in your setup (Left or Right side) and select **Continue**.

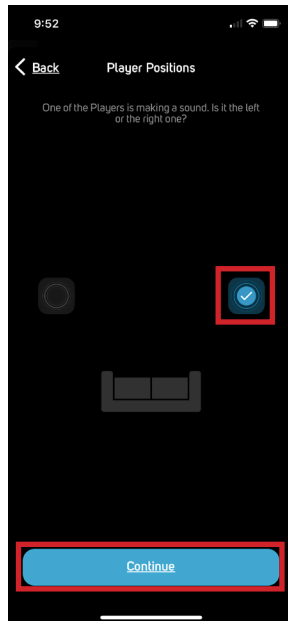

The setup process will continue automatically. It will pass through **Linking to Secondary**, checking for upgrades to your Speakers (**Preparing**) and automatically updates your Speaker if upgrade is available. Do not interrupt or power down your Alpha iQ during this stage of the setup process.

Important During this stage of the setup process, **Linking to Secondary** and **Preparing** may take up to 15 minutes to complete. This is normal. Do not interrupt or power down your Alpha iQ during this stage of the setup process.

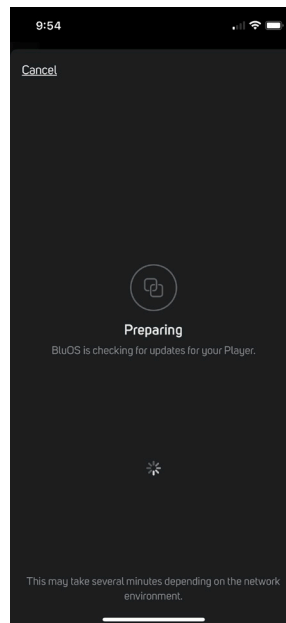
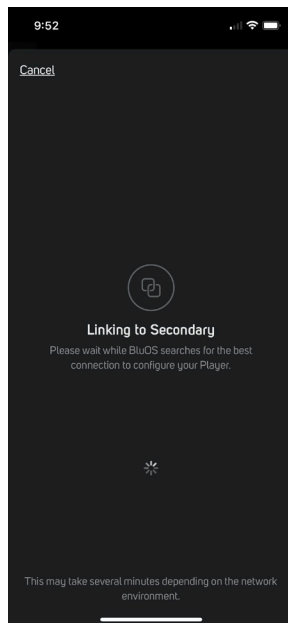

10. When **Setup Complete** is shown in the App, this indicates that your Alpha iQ is ready for use. Select **Finish** to complete and exit the setup process.

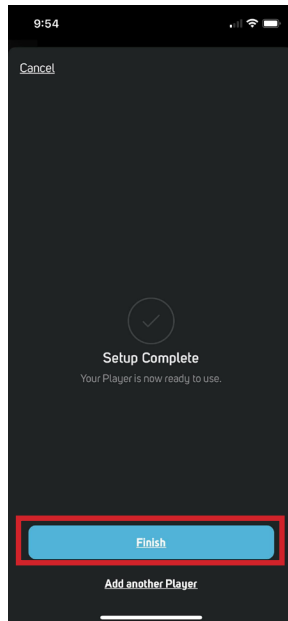

Factory Reset

Your Alpha iQ can be factory reset or restored to factory default settings if your Alpha iQ is not functioning or internet firmware upgrade has failed. All customizations including Wi-Fi network configuration, file shares and saved playlists will be lost. They have to be re-created once factory reset is completed.

Steps to Factory Reset

Factory reset the Primary Speaker and Secondary Speaker separately.

Primary Speaker

1. Disconnect the Primary Speaker from mains power outlet. Remove the Ethernet cable from the Primary Speaker LAN port if applicable.
2. Wait for 30 seconds and then reconnect the power.
3. As soon as the Status Indicator LED turns Red, press and hold the >|| (Play/Pause) button. The Status Indicator LED will immediately turn Green and then back to Red - continue to hold >|| (Play/Pause) button for 30 seconds.

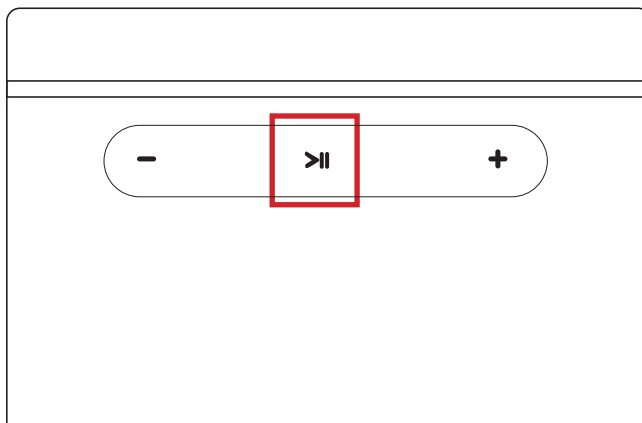

4. After 30 seconds, the Status Indicator LED will begin to blink red – release hold of the >|| (Play/Pause) button.
5. The Status Indicator will turn Green. This indicates that the factory reset of the Primary Speaker is completed and is now at Hotspot mode ready to be configured.

Secondary Speaker

1. Disconnect the Secondary Speaker from mains power outlet. Position a tool with pointed tip (for example, paper clip) to reach and contact the SERVICE tact switch – do not touch the SERVICE tact switch with the tool yet.

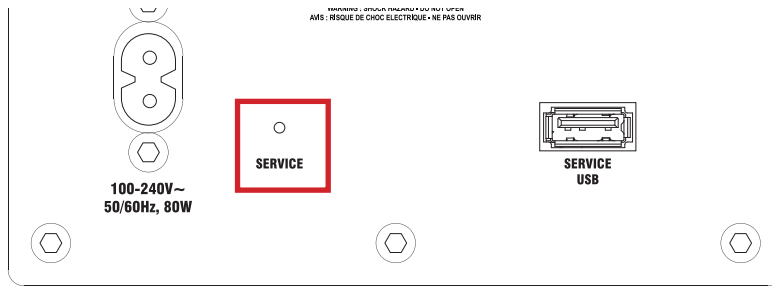

2. Wait for 30 seconds and then reconnect the power.
3. As soon as the Status Indicator LED turns Red, press and hold the SERVICE tact switch with the pointed tip of the tool. The Status Indicator LED will immediately turn Green and then back to Red - continue to hold for 30 seconds the SERVICE tact switch with the pointed tip of the tool.
4. After 30 seconds, the Status Indicator LED will begin to blink red – release hold of SERVICE tact switch.
5. The Status Indicator will turn Green. This indicates that the factory reset of the Secondary Speaker is completed and is now at Hotspot mode ready to be configured and paired.

Important Note Releasing >II (Play/Pause) or SERVICE tact switch before the Status Indicator LED blinks Red will cancel the factory reset process and leave the Alpha iQ at Upgrade Mode. Just start again the procedure for Factory Reset.

Positioning

- I. As symmetrically as possible, place your Alpha iQ Primary and Secondary Speakers at a comfortable listening location with no obstructions at the front or back.
- II. We recommend at least three inches of clearance around the back of both speakers. Good air circulation is required for heat dissipation, and to ensure proper performance of the rear-firing ports. Similar positioning and clearance should be used for both speakers. To maintain high resolution performance and consistent transmission, the speakers should be placed within 15 ft from each other.

For more detailed information about speaker placement, please visit www.psbSpeakers.com.

Protecting your Investment

For long lasting enjoyment of your PSB product, you should respect their limits and avoid excessive volume levels for music or movie playback. Excessive volume levels can damage all types of speakers. If your speakers are pushed to excessive volume levels, they could be driven into “clipping”, which may result in severe and/or permanent damage.

When listening to your speakers at loud levels, listen carefully for any signs of harsh, distorted midrange and diminishing precision. If detected, turn the volume down immediately.

NEVER TEST PEAK LISTENING LEVELS OF YOUR SPEAKERS BY TURNING THE VOLUME TO THE MAXIMUM LEVEL.

Care and Cleaning

For safe, sanitary use, it is essential to maintain and clean your speakers periodically. However, excessive cleaning may cause damage and jeopardize the longevity of the product. When not in use, avoid storing in extreme hot or cold temperatures and humidity, and avoid exposure to liquids.

Packaging

We highly recommend retaining all product packaging for any necessary transport. To transport, carefully place the speakers into their original packaging and close each panel.

Cabinet Care

PSB cabinets have varying materials and finishes and should be treated with the same care you would with similar finishes such as on furniture. Dust lightly with a soft cloth, avoiding abrasive materials that will cause permanent damage to the cabinet. If necessary, wipe carefully with a cloth slightly dampened with water-based cleaner to remove heavy soil.

Drivers and Port Care

During light cleaning, avoid touching speaker diaphragms as it could cause permanent damage to the tweeter and/or drivers. To clean the driver ports, we suggest using lint-free cloth.

Environmental Protection

At the end of its useful life, this product must be returned to a collection point for the recycling of electrical and electronic equipment. Do not dispose with regular household waste.

SPECIFICATIONS

FREQUENCY RESPONSE

On Axis @ 0° ± 3dB	64Hz-20kHz
LF Cutoff -10dB	35Hz

AMPLIFIER POWER

Amplifier Power (per speaker)	Tweeter = 30 watts, Woofer = 60 Watts
-------------------------------	---------------------------------------

ACOUSTIC DESIGN

Tweeter (Nominal)	3/4" (19mm) Aluminium Dome with Ferrofluid and Neodymium Magnet
Woofer (Nominal)	4" (100mm) Cone Rubber Surround Steel Basket
Design Type	Bass Reflex

ACOUSTIC DESIGN

Analog	3.5mm, Phono MM
Digital	BluOS, HDMI eARC, Optical
Wireless	aptX™ HD Bluetooth (Sink and Source, 2-way)

CONSTRUCTION

Cabinet Sleeve	MDF
Front Baffle	MDF on Aluminum
Rear Baffle	Aluminum

SIZE (W x H x D)

Net Dimensions	5 11/16" x 9 11/16" x 7 5/8" (145 x 246 x 192 mm)
Net Weight	7.36 kg/16.2 lbs (pair)
Gross Weight	8.27 kg/18.2 lbs (pair)
Shipping Dimensions	10 2/5" x 15 13/16" x 15 3/16" (268 x 402 x 385 mm)

FINISH

Available Finish	Painted, Matte Black, Matte White
------------------	-----------------------------------

PSB Speakers
633 Granite Court Pickering, Ontario. L1W 3K1
CANADA

www.psbSpeakers.com
888-772-0000
(905) 831-6555
Fax: 905-831-6936

